

### SPECIFICATIONS:

Encryption.....	Keeloq Code-Hopping
Frequency.....	403.55MHz
Receiving range.....	500m
Power input range.....	10 ~ 26V AC/DC
Current drain.....	13mA, 12VDC
Memory capacity.....	64 Remotes per Channel
Relay output times.....	0.5; 1; 3; 30 second momentary
.....	1 & 3 Minute
.....	Latching
.....	On / Off function
Dimensions.....	148 X 63 x 41mm
Weight Packed.....	0.190kg / 190grams
Warranty.....	1 year
PCB Revision no.....	RX4-500_V3.5
Release date.....	Aug 2010

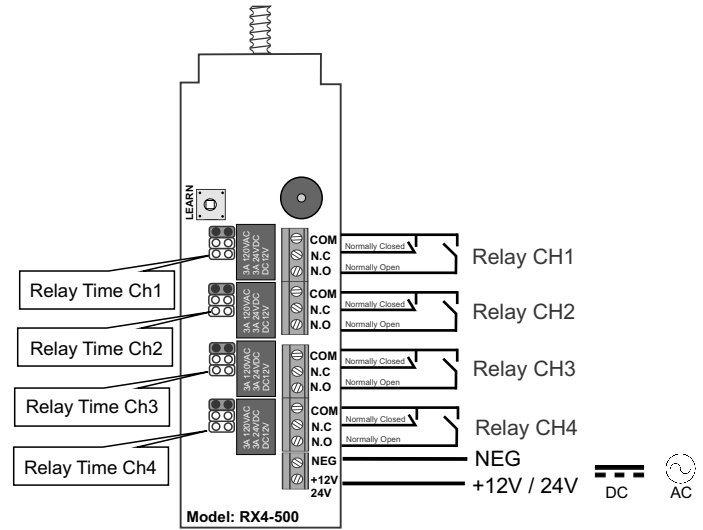

### Mounting

The unit should be mounted Vertically for best performance. Ensure that you do not mount the unit close to electric fence cables or energizers, as this may reduce the performance of the product.

We recommend you to mount the unit more than 2 metres above the floor. You may need to move the unit if you encounter dead spots. In rare cases you may need to install a Repeater unit for coverage around large buildings.

### Opening

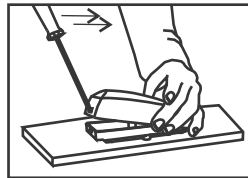

Insert a small 1-1.5mm flat screw driver into the slot at the back of the housing and lever the lid open.

### Defaulting.



Remove all jumpers off the Relay Time Headers



Press and hold for more than 10 Seconds.

This function will Default (Erase all) remotes from memory

Note: If you want to just Default a specific relay channel then just remove the jumpers off the Relay time header for that particular channel.

### Programming

Please follow the steps below to Learn in remotes to the receiver's relevant relay channel. The unit can store up to 64 remotes per relay. When memory has reached its limit the unit will automatically exit out of program mode and sound a long beep. The unit auto exits after 10 seconds.

<b>Step 1.</b> 1 beep Press to enter into Learn mode	<b>Step 2.</b> 2 beeps Press each remote to be learnt into the Relay Channel twice. Max 64 Remotes per Relay.	<b>Step 3.</b> 1 beep Press to advance to the next Relay Channel. Then follow Step 2 again three times.	<b>Step 4</b> Long beep Once Relay Channel 4 is programmed, press once more to exit out of Learn Mode
--	---	---	---

### Programming On/Off Function

This function enables the receiver to be programmed with a button to turn the relay ON and a different button to turn the relay OFF. Follow the steps below for each Relay Channel.

<b>Step 1.</b> 2 beeps Enters Learn for ON/OFF	<b>Step 2.</b> 3 beeps Learn ON signal Press button twice	<b>Step 3.</b> 3 beeps Enters into Learn mode for the OFF code	<b>Step 4.</b> 6 beeps To learn the OFF signal press the button twice	<b>Step 5.</b> Long beep Press the advance to the next relay channel. Follow step 2 again.
--	---	--	---	--

### Relay time settings

#### 0.5 Second

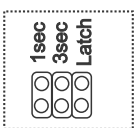

Gate & garage door automation

#### 1 Second

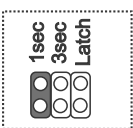

Gate & garage door automation

#### 3 Seconds

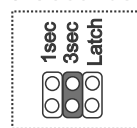

Panic on alarm panel

#### 30 Seconds

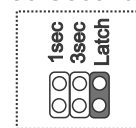

Maglock release

#### Latch & Unlatch

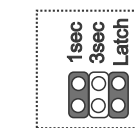

Arming & Disarming alarm panels

#### 1 Minute

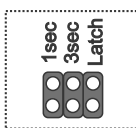

Beam / Zone bypass

#### 3 Minutes

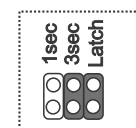

Siren output or beam bypass

#### On / Off

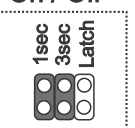

Code 1 = ON  
Code 2 = OFF