

The CENTURIUM and CENTSYS logos, all product and brand names in this document that are accompanied by the TM symbol are trademarks of Centurion Systems (Pty) Ltd, in South Africa and other territories. All rights are reserved. We invite you to contact us for further details.

EOE Centurion Systems (Pty) Ltd reserves the right to change any product without prior notice. All product and brand names in this document that are accompanied by the @ symbol are registered trademarks in South Africa and/or other countries, in favour of Centurion Systems (Pty) Ltd, South Africa.

After Hours International Technical Support Call Centre  
 +27 11 699 2481 (16:00 to 02:00 - Australian Eastern Time)  
 Call: 1300 CENTSYS (1300 236 879)  
 www.centsys.com.au  
 Call Technical Support: +27 11 699 2481  
 from 08h00 to 17h00 (UTC+2)  
 Head Office: +27 11 699 2400  
 Call Centurion Systems (Pty) Ltd - South Africa

Subscribe to the newsletter:  
 www.centsys.com/subscribe

centurion.systems

@askcenturion

YouTube.com/centurionsystems

facebook.com/centurionsystems

Connect with us on:

www.centsys.com



**GSM-BASED INTERCOM SYSTEM**

**G-SPEAK ULTRA QUICK GUIDE**



**G-SPEAK ULTRA**

**1. Important Safety Instructions**

- Do not install this product near DOSS sensor inside gate motor housing or near the remote receiver.
- Do not install this product near any sensitive electrical components.
- All installation, repair, and service work to this product must be done by a suitably-qualified person.
- Do not in any way modify the components of the system.
- Do not install the equipment in an explosive atmosphere: the presence of flammable gas or fumes is a serious danger to safety.
- Do not leave packing materials (plastic, polystyrene, etc.) within reach of children as such materials are potential sources of danger.
- Dispose of all waste products like packing materials, according to local regulations.
- Centurion Systems (Pty) Ltd does not accept any liability caused by improper use of the product, or for use other than that for which the automated system was intended.
- This product was designed and built strictly for the use indicated in this documentation. Any other use, not expressly indicated here, could compromise the service life/operation of the product and/or be a source of danger.
- Anything not expressly specified in these instructions is not permitted.

This icon denotes variations and other aspects that should be considered during installation.

This icon indicates tips and other information that could be useful during the installation.

**2. Technical Specifications**

Supply Voltage Range	11-24V DC
Maximum Current Draw	300mA @ 12V DC
Input/output Current Rating	50mA (Open Collector)
Input Sense Voltage Range	0-24V DC (0-1.6V Low-input State, 5V-24V High-input State)
<b>Network Provider</b>	<b>MTN - South Africa Only</b>
Number of Configurable Input/output Channels	4
Call Buttons on Calling Module	2
Call confirmation at Calling Module	Yes
Model Options	<b>GSM 2G:</b> 850/900/1800/1900MHz (EDGE) <b>GSM 3G:</b> 900/2100MHz (EDGE) 900/2100MHz (UMTS) <b>GSM 3G PENTA:</b> 800/850/900/1900/2100MHz (UMTS) <b>GSM 4G/LTE-CAT1:</b> 900/2100MHz
Degree of protection (G-SPEAK ULTRA)	IP40
Degree of protection (Calling Module)	IP52

TABLE 1

**3. Product Identification**

**3.1. G-SPEAK ULTRA**



FIGURE 1

- Fascia
- External Antenna Cover
- Main Unit
- Mounting Plate
- Terminal Blocks
- Navigation panel
- LCD Screen

**4. Device Layout and Wire Connections**

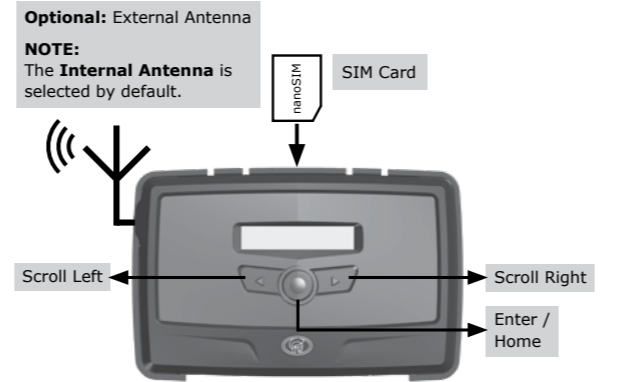

**5. LCD Interface**

Table 2 below lists the information shown on the different screens found on the LCD interface. The left and right scroll buttons are used to toggle between the different screens.

<b>Vodacom</b>	<b>Home Screen</b> Network Name or Phone Number Applicable to Incoming / Outgoing SMS or Call. Network Signal Strength Connected to Internet Connected to G-WEB Device has Error Condition Incoming SMS Outgoing SMS Incoming Phone Call Events Outgoing Phone Call Events
IO1 IO2 IO3 IO4	<b>IO Status Screen</b> Input: Deactivated ("E" = Input event reached) Input: Activated (pulled to ground) ("E" = Input event reached) Output: Off Output: On (pulling to ground)
12.1V Fw:1.01 21:21 1/1/17	<b>Voltage/Firmware/Date &amp; Time Screen</b> Supply Voltage Firmware Version Time Date
0715493849	<b>Phone Number Screen</b> Device SIM Phone Number.
Your balance is R10	<b>Airtime Balance Screen</b> Press Enter to Refresh Airtime Balance from Network Provider.
Internal GSM Antenna Selected	<b>GSM Antenna Selected Screen</b> Internal GSM Antenna Selected (default). External GSM Antenna Selected (connect own Antenna to SMA connector). Press Enter to change between Internal and External Antennas.
IO1 IO2 IO3 IO4	<b>Gate Status Screen</b> Gate Closed Gate Opening Gate Open Gate Status Warning
SIM PIN: 0000 1/3	<b>SIM Screen</b> SIM PIN OK SIM PIN Incorrect SIM Error
G-SPEAK ULTRA IMEI:8958 5649 5649 982	<b>IMEI Screen</b> Displays the device's IMEI number

+27723498576 NA	<b>Gate Station Voice Numbers</b> Displays the primary and secondary Voice Numbers allocated to their respective buttons
+27723498576 +27713439987	

**6. Configurations**

**6.1. Removing the Mounting Plate and Fascia**

To access the terminal blocks of the G-SPEAK ULTRA, the back plate and fascia need to be removed. Follow the instructions below to do this.

**6.1.1. Removing the Mounting Plate**

Gently pull the two clips at the back backward to release the main G-SPEAK ULTRA unit, and lift the unit out of the mounting plate.

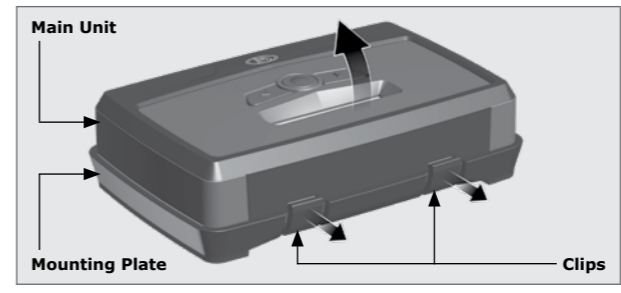

FIGURE 3

**6.1.2. Removing the Fascia**

The fascia can be removed by inserting the tips of one's fingers into the slots (as shown in Figures 4 and 5), and pulling outward and upward. The fascia should pop off without effort.

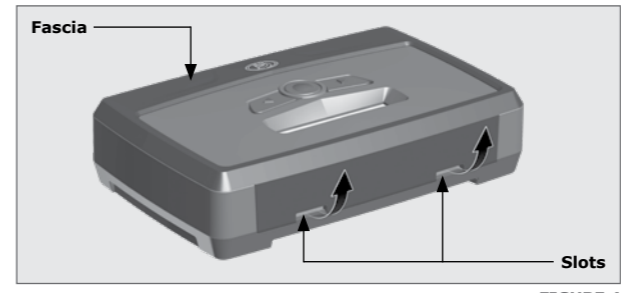

FIGURE 4

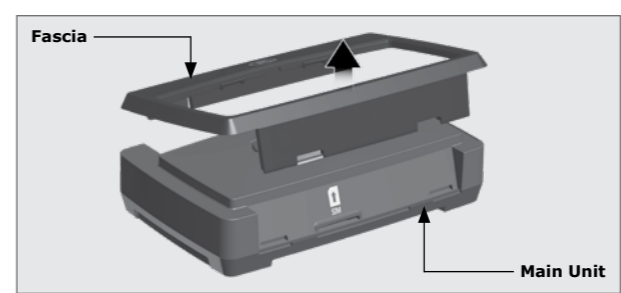

FIGURE 5

Reverse the procedure under Section 6.1 to re-assemble the G-SPEAK ULTRA.

**6.2. Calling Module**

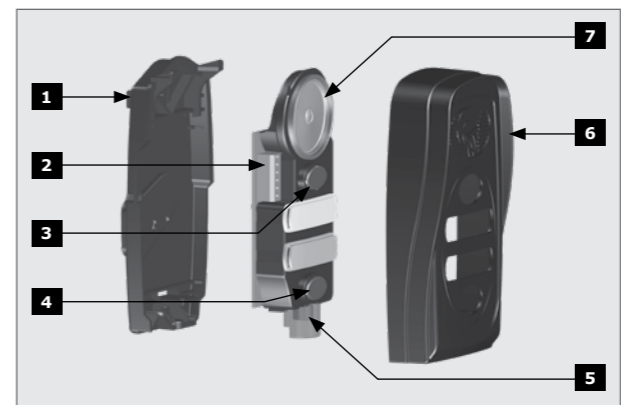

FIGURE 6

- Back Cover / Mounting Panel
- Voice Communication Terminals
- Call Button 1
- Call Button 2
- Microphone
- Front Cover / Fascia
- Speaker

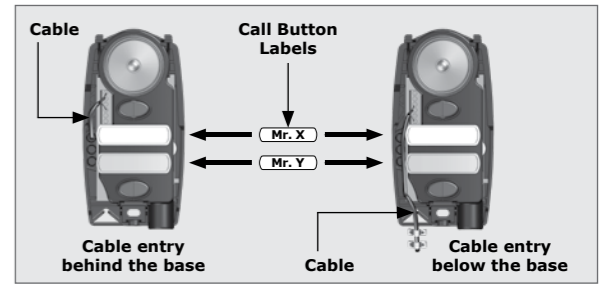

FIGURE 7

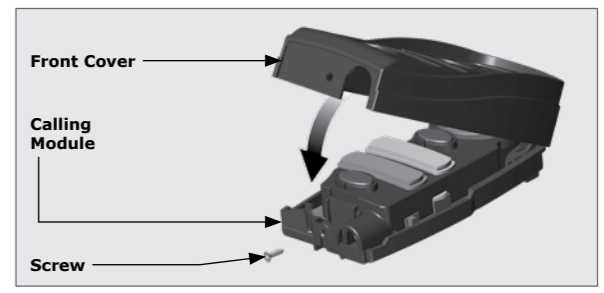

FIGURE 8

GND	IO1	IO2	IO3	IO4	P1	P2	P3	P4	P5	P6	VIN	NEG
-----	-----	-----	-----	-----	----	----	----	----	----	----	-----	-----

GND	Ground
IO1	Input / Output 1 (Default: Output)
IO2	Input / Output 2 (Default: Output)
IO3	Input / Output 3 (Default: Output)
IO4	Input / Output 4 / Gate Status Input (Default: Output)
P1	Data Communication Line
P2	Data Communication Line
P3	Data Communication Line
P4	Data Communication Line
P5	Data Communication Line
P6	Data Communication Line
VIN	Positive of Power Supply 12-24VDC
NEG	Negative of Power Supply

TABLE 3



**6.3. Wiring Diagrams (Please refer to the online G-ULTRA wiring diagram document for more diagrams)**

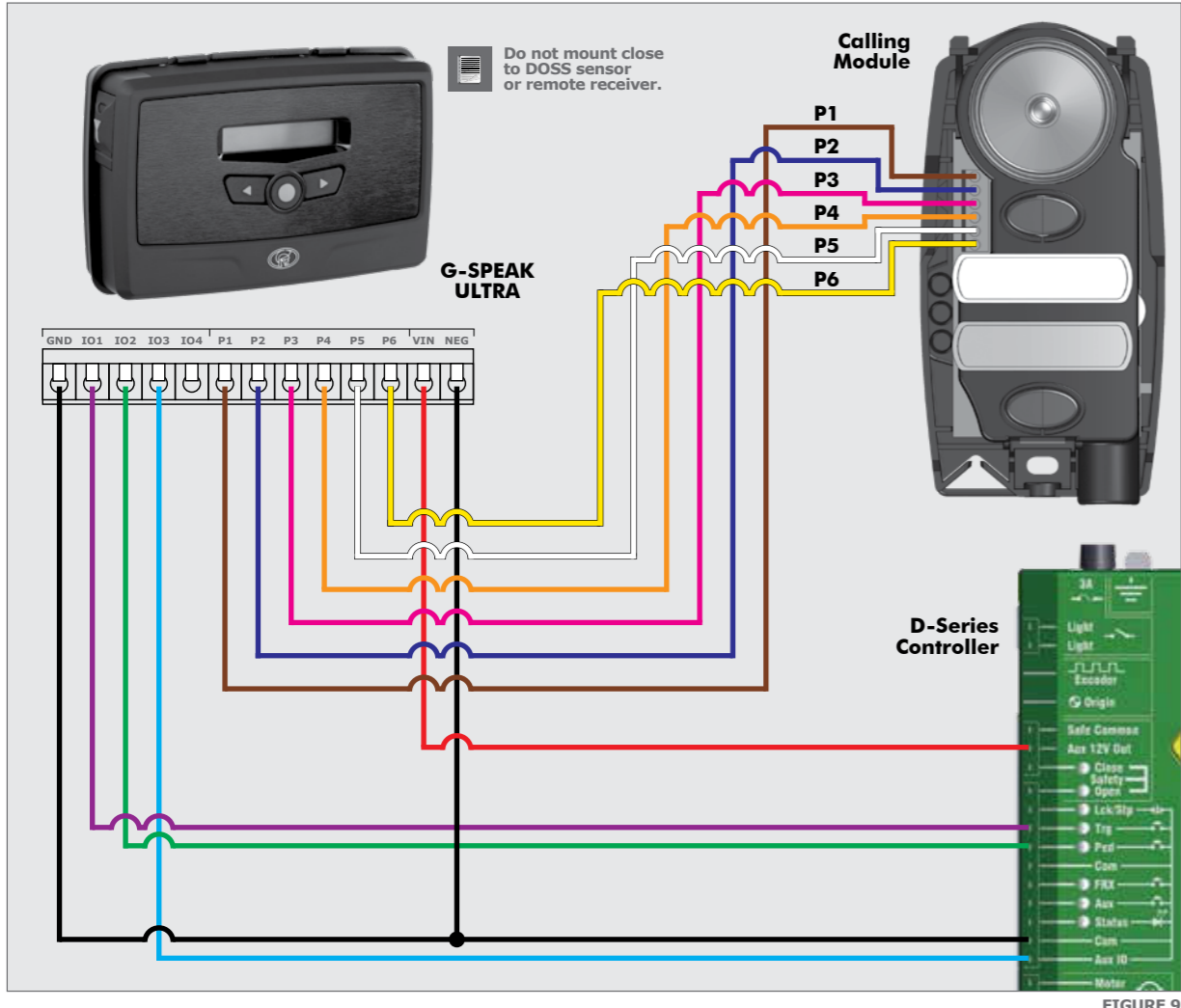

Looking for more wiring diagrams and product applications? Scan the QR code on your mobile device to be taken to our wiring diagram library.



**6.4. Configuration of features**

All features – both basic and advanced – can be easily, and remotely, configured via our G-WEB Mobile Phone App or our G-WEB Online Interface. By simply logging on to the G-WEB App or G-WEB, one can add and delete users, specify text for input notifications and activations, modify device characteristics and many other features.

Download the G-WEB mobile App from your Smart Phone by navigating to the App store.

It would be necessary to register if you have not previously done so.

**6.4.1. G-WEB Mobile App (Installers)**

To download the G-WEB Mobile installer app, simply scan the QR code on your mobile device to be taken to the app in the applicable app store for your operating system. The G-WEB app gives you on-the-go access to a multitude of configuration and admin settings.

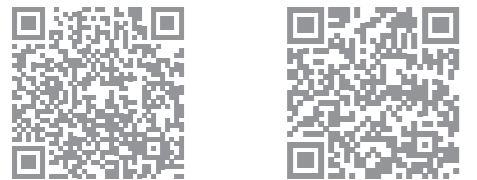

There is no need to download a third party QR Scanner, as there is a QR Scanner that is built into the G-WEB Ultra Mobile App.

**6.4.2. G-WEB Online (Installers)**

Your CENTURION GSM devices can be remotely managed and configured using the G-WEB online interface. Navigate your Internet browser to <http://www.gweb.co.za> (or [www.g-web.com.au](http://www.g-web.com.au) for Australia and New Zealand) and login to your existing profile or, alternatively, register a new profile.



**6.4.3. MyCentsys Remote Mobile App (Users)**

Download the MyCentsys Remote mobile app now for free by scanning the QR code on your mobile device. MyCentsys Remote lets you remotely control your GSM devices from your phone and receive push notifications for systems that are being monitored.

**SCAN THIS QR CODE TO DOWNLOAD YOUR MANUALS, BROCHURES AND OUR LATEST APPLICATIONS FOR THE ULTIMATE SMART EXPERIENCE**



Control and monitor your ULTRA and SMART solutions from this mobile application

Easy and intuitive management of G-Speak ULTRA devices from app or web interface

SMART Documentation at your fingertips

