

# SD Card Reader Stands

Strong single and dual height reader stands with multiple mounting options



*SD Card Reader stands accommodate a range of access control accessories including proximity readers, intercoms, push buttons, cameras and access keypads.*

Integrated rain and sun shields make these card reader stands suitable for both indoor and outdoor applications.

There are many other variations available to suit your requirements. Custom sizes and colours are available on request.

## Reader Mounting Options



**130 x 200mm Flat Plate:**  
powder coated stainless steel, suitable for mounting 1 x intercom, or keypad or reader



**190 x 390mm Mounting Box:**  
aluminium mounting plate suitable for a combination of 2 x units (intercom and/or keypad and/or reader)



**349 x 390mm Mounting Box:**  
acrylic black mounting plate suitable for mounting all 3 units (intercom, keypad and reader)

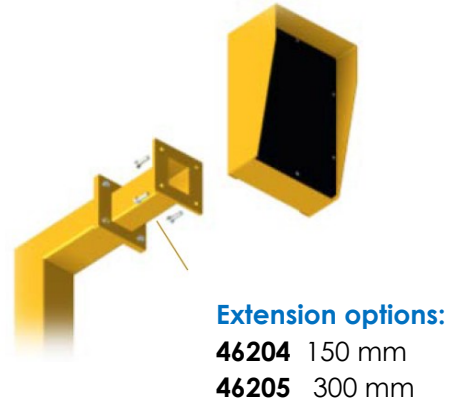

**Extension options:**  
**46204** 150 mm  
**46205** 300 mm

**Standard ex-stock colour options:**  
 Choose from either a yellow or black powder coated finish.

## Dimensions

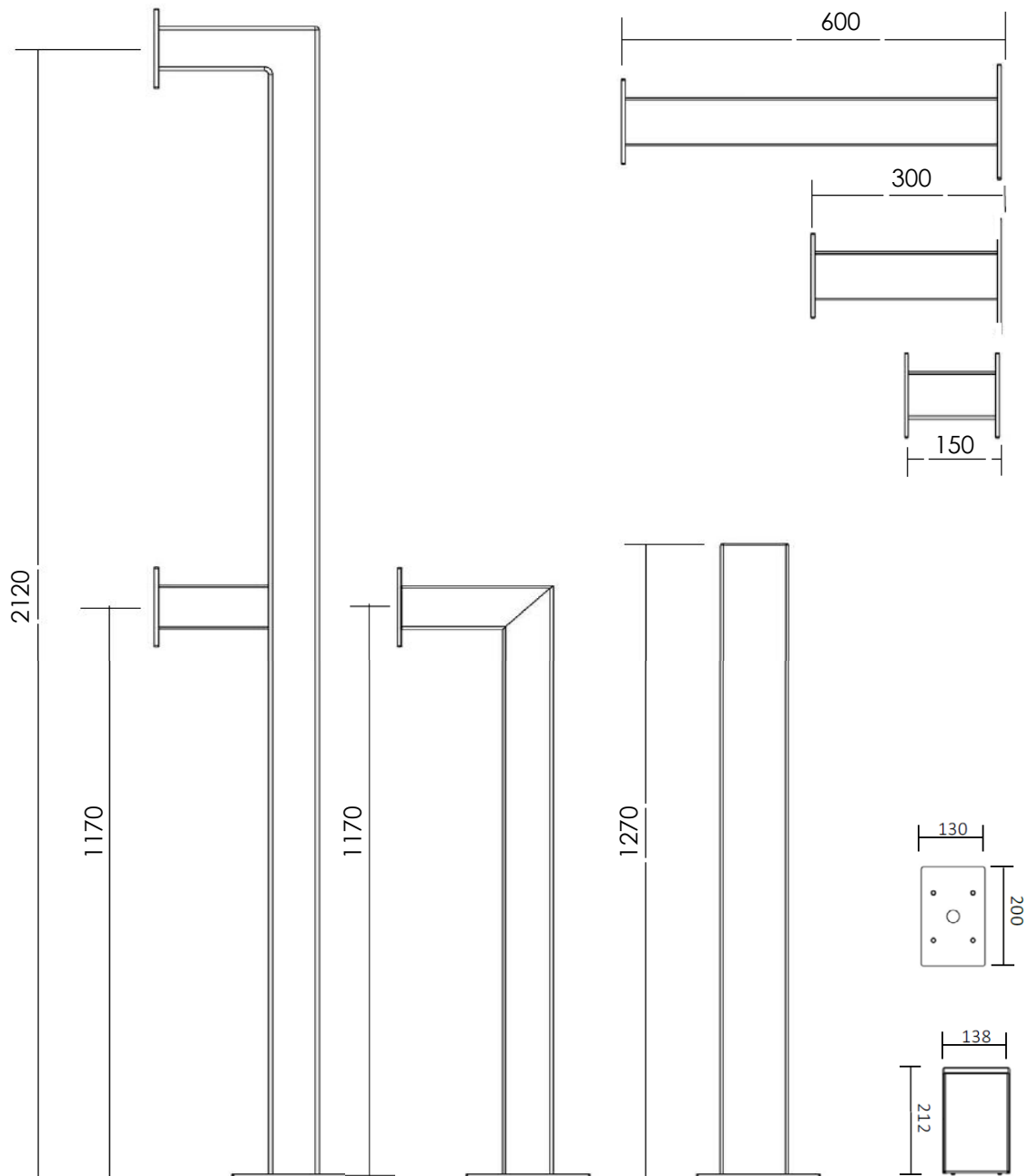

### WALL AND BASE PLATE DIMENSIONS:

182 x 182mm Square

(Mounting holes 14mm diameter - 140mm between centres).

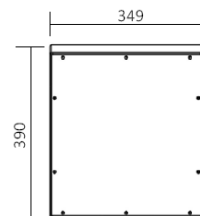
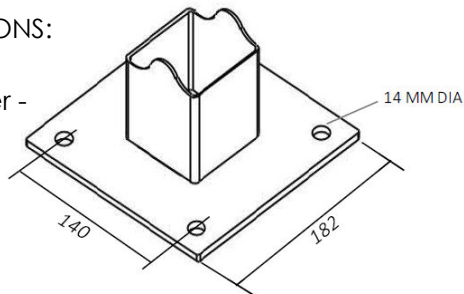

Rotech supply all forms of door and gate automation

#### Vehicle Access Control

- Booms Gates
- Sliding Gates
- Swing Gates
- Industrial Door Openers
- Solar Powered Gate Openers

#### Pedestrian Access Control

- Full Height Turnstiles
- Waist Height Turnstiles
- Supermarket Gates/Turnstiles
- Wheelchair Access Gates
- Rapid Access Gates

**Fast | Safe | Secure**